



WINDSOR
WINDOWS & DOORS
A Woodgrain Millwork Company



PATIO DOORS

WOOD CLAD AND VINYL OPTIONS FROM WINDSOR WINDOWS & DOORS

www.windsorwindows.com



Table of Contents

Pinnacle Swinging Patio Doors	5-7
Pinnacle Sliding Patio Doors	8-9
Pinnacle Bi-fold Patio Doors.....	10-11
Pinnacle Multi-slide Patio Doors	12-15
Next Dimension Sliding Patio Doors.....	16-17
Options & Accessories	18-22



**PINNACLE 3/4 LITE
OUT-SWING PATIO DOOR.**
Bluffton, South Carolina
*(Courtesy of Coastal Living
Magazine/Josh Gibson).*



**PINNACLE IN-SWING PATIO DOOR
WITH SIDELITES AND SWINGING
SCREENS.** Silver Lake, Wisconsin.

Imagine a Solution for Any Situation

Windsor Windows & Doors can help bring your vision to life.

Our windows and doors open up a home to the light, air and beauty of the outside world. But it's the inspired designs and lasting performance of Windsor products that open up a world of possibilities for architects and builders.

Windsor has been developing unique home construction solutions for more than 70 years. We're dedicated to bringing you the highest quality products on the market, all for the best value.

Choose from a wide selection of products for new construction, remodeling or light commercial applications. Windsor's windows and doors allow you to get creative with your next project, without sacrificing quality or stretching your budget.

Imagine what you can do with Windsor Windows & Doors.



PINNACLE DIRECT SET WINDOWS AND IN-SWING PATIO DOOR.
Waukee, Iowa.



PINNACLE CASEMENT, DIRECT SET AND PICTURE WINDOWS, AND IN-SWING PATIO DOOR. Cleveland, Ohio.

Pinnacle Swinging Patio Doors

The highlight of a house. Your patio is an extension of your home, and your home is an extension of yourself and your style. That's why at Windsor we offer you several options for our Pinnacle swinging patio doors. Choose from in-swing or out-swing models. Add architectural interest to any project by choosing a curved seg-top patio door. Select one panel to operate or two panels. Include up to four panels in one frame. For safety, we can install multi-point locking hardware – for style, we can accent your doors

with a customized transom, radius or sidelites. A complement to any home's décor, Windsor's beautifully crafted 1/2 and 3/4 lite panel doors are available in the finest wood interior finishes and offer more customizable features with one or two flat panels. The design options continue, with more than 50 different exterior clad colors and finishes, several hardware styles, multiple hardware finishes and numerous grille options.

NOTE: Primed in-swing patio doors come standard with cellular PVC exterior trim.

pinnacle swinging patio doors





Pinnacle In-swing Patio Door

Experience the beauty and performance of wood, available in clad or primed exterior.

- Clad doors available in heavy-duty extruded aluminum cladding; primed doors come standard with cellular PVC exterior trim for a traditional, decorative appearance
- Clad doors available in Clear Select Pine, Douglas Fir, Natural Alder, primed, painted white or painted black interior finishes; primed doors available in Clear Select Pine, primed or painted white interior finishes
- All clad colors painted in-house with the highly durable AAMA 2604 standard finish, or upgrade to AAMA 2605 for the most challenging of environments – 22 standard colors; 21 feature colors; 8 anodized finishes; custom colors available
- “Easy Adjust” hinge system for effortless operation and correction after installation; non-removable-pin ball bearing hinge also available
- Active stiles constructed of an LVL core material for added strength and stability
- Dual-seal frame weatherstripping at panel face and edge improves air and thermal performance
- Wept sill system to eliminate water infiltration
- Heavy-duty, self-adjusting sweep
- Single or bi-hinge panel operation
- Panels available in traditional French or contemporary narrow stile
- Integral structural astragal allows for doors up to 12 feet wide to be placed in a single frame, which decreases the potential for air and water infiltration
- Oak interior sill; exterior sill available in mill or bronze anodized finishes
- Rigid aluminum nail fin
- Stainless steel multi-point locking hardware option for added security
- 1/2 and 3/4 lite available with flat or split panel option
- Seg-top available
- Five standard heights: 6'8", 6'10", 8'0", 9'0" and 10'0" (9'0" and 10'0" doors available in French panels only)

PINNACLE IN-SWING PATIO DOOR. Alpine, Utah.

Measurements* Widths and heights are rough opening dimensions. (P = Primed • C = Clad)

Single Panel Units

UNIT	P-WIDTH	C-WIDTH	HEIGHT	For Seg-top			
				C-LEG	C-RADIUS	P-LEG	P-RADIUS
2668	2-6 15/16	2-7	6-8	-	-	-	-
26610	2-6 15/16	2-7	6-10 7/8	6-7 1/32	3-0	6-7 1/16	3-0
26880	2-6 15/16	2-7	7-11 7/8	7-8 1/32	3-0	7-8 1/16	3-0
2690	2-6 15/16	2-7	8-11 7/8	8-8 1/32	3-0	8-8 1/16	3-0
26100	2-6 15/16	2-7	9-11 7/8	-	-	-	-

Single Panel Units

UNIT	P-WIDTH	C-WIDTH	HEIGHT	For Seg-top			
				C-LEG	C-RADIUS	P-LEG	P-RADIUS
2868	2-8 15/16	2-9	6-8	-	-	-	-
28610	2-8 15/16	2-9	6-10 7/8	6-6 9/16	3-0	6-6 9/16	3-0
2880	2-8 15/16	2-9	7-11 7/8	7-7 9/16	3-0	7-7 9/16	3-0
2890	2-8 15/16	2-9	8-11 7/8	8-7 9/16	3-0	8-7 9/16	3-0
28100	2-8 15/16	2-9	9-11 7/8	-	-	-	-

Single Panel Units

UNIT	P-WIDTH	C-WIDTH	HEIGHT	For Seg-top			
				C-LEG	C-RADIUS	P-LEG	P-RADIUS
3068	3-0 15/16	3-1	6-8	-	-	-	-
30610	3-0 15/16	3-1	6-10 7/8	6-5 15/32	3-0	6-5 1/2	3-0
3080	3-0 15/16	3-1	7-11 7/8	7-6 15/32	3-0	7-6 1/2	3-0
3090	3-0 15/16	3-1	8-11 7/8	8-6 15/32	3-0	8-6 1/2	3-0
30100	3-0 15/16	3-1	9-11 7/8	-	-	-	-
3268	3-2 7/16	3-2 1/2	6-8	-	-	-	-
32610	3-2 7/16	3-2 1/2	6-10 7/8	6-5 1/32	3-0	6-5 1/16	3-0
3280	3-2 7/16	3-2 1/2	7-11 7/8	7-6 1/32	3-0	7-6 1/16	3-0
3290	3-2 7/16	3-2 1/2	8-11 7/8	-	-	-	-
32100	3-2 7/16	3-2 1/2	9-11 7/8	-	-	-	-

Double Panel Units

UNIT	P-WIDTH	C-WIDTH	HEIGHT	For Seg-top			
				C-LEG	C-RADIUS	P-LEG	P-RADIUS
5068	5-0 3/4	5-0 13/16	6-8	-	-	-	-
50610	5-0 3/4	5-0 13/16	6-10 7/8	6-5 9/16	8-0	6-5 9/16	8-0
5080	5-0 3/4	5-0 13/16	7-11 7/8	7-6 9/16	8-0	7-6 9/16	8-0
5090	5-0 3/4	5-0 13/16	8-11 7/8	8-6 9/16	8-0	8-6 9/16	8-0
50100	5-0 3/4	5-0 13/16	9-11 7/8	-	-	-	-

Double Panel Units

UNIT	P-WIDTH	C-WIDTH	HEIGHT	For Seg-top			
				C-LEG	C-RADIUS	P-LEG	P-RADIUS
5468	5-4 3/4	5-4 13/16	6-8	-	-	-	-
54610	5-4 3/4	5-4 13/16	6-10 7/8	6-4 7/8	8-0	6-4 7/8	8-0
5480	5-4 3/4	5-4 13/16	7-11 7/8	7-5 7/8	8-0	7-5 7/8	8-0
5490	5-4 3/4	5-4 13/16	8-11 7/8	8-5 7/8	8-0	8-5 7/8	8-0
54100	5-4 3/4	5-4 13/16	9-11 7/8	-	-	-	-

Double Panel Units

UNIT	P-WIDTH	C-WIDTH	HEIGHT	For Seg-top			
				C-LEG	C-RADIUS	P-LEG	P-RADIUS
6068	6-0 3/4	6-0 13/16	6-8	-	-	-	-
60610	6-0 3/4	6-0 13/16	6-10 7/8	6-3 11/32	8-0	6-3 3/8	8-0
6080	6-0 3/4	6-0 13/16	7-11 7/8	7-4 11/32	8-0	7-4 3/8	8-0
6090	6-0 3/4	6-0 13/16	8-11 7/8	8-4 11/32	8-0	8-4 3/8	8-0
60100	6-0 3/4	6-0 13/16	9-11 7/8	-	-	-	-
6468	6-3 3/4	6-3 13/16	6-8	-	-	-	-
64610	6-3 3/4	6-3 13/16	6-10 7/8	6-2 23/32	8-0	6-2 3/4	8-0
6480	6-3 3/4	6-3 13/16	7-11 7/8	7-3 23/32	8-0	7-3 3/4	8-0
6490	6-3 3/4	6-3 13/16	8-11 7/8	-	-	-	-
64100	6-3 3/4	6-3 13/16	9-11 7/8	-	-	-	-

Triple Panel Units

UNIT	P-WIDTH	C-WIDTH	HEIGHT	For Seg-top			
				C-LEG	C-RADIUS	P-LEG	P-RADIUS
7668	7-6 9/16	7-6 5/8	6-8	-	-	-	-
76610	7-6 9/16	7-6 5/8	6-10 7/8	6-3 3/16	12-0	6-3 3/16	12-0
7680	7-6 9/16	7-6 5/8	7-11 7/8	7-4 3/16	12-0	7-4 3/16	12-0

Triple Panel Units

UNIT	P-WIDTH	C-WIDTH	HEIGHT	For Seg-top			
				C-LEG	C-RADIUS	P-LEG	P-RADIUS
8068	8-0 9/16	8-0 5/8	6-8	-	-	-	-
80610	8-0 9/16	8-0 5/8	6-10 7/8	6-2 5/32	12-0	6-2 3/16	12-0
8080	8-0 9/16	8-0 5/8	7-11 7/8	7-3 5/32	12-0	7-3 3/16	12-0

Triple Panel Units

UNIT	P-WIDTH	C-WIDTH	HEIGHT	For Seg-top			
				C-LEG	C-RADIUS	P-LEG	P-RADIUS
9068	9-0 9/16	9-0 5/8	6-8	-	-	-	-
90610	9-0 9/16	9-0 5/8	6-10 7/8	5-11 29/32	12-0	5-11 29/32	12-0
9080	9-0 9/16	9-0 5/8	7-11 7/8	7-0 29/32	12-0	7-0 29/32	12-0

Bi-hinge Units (only)

UNIT	P-WIDTH	C-WIDTH	HEIGHT	For Seg-top			
				C-LEG	C-RADIUS	P-LEG	P-RADIUS
4068	4-0 3/4	4-0 13/16	6-8	-	-	-	-
40610	4-0 3/4	4-0 13/16	6-10 7/8	6-7 5/16	8-0	6-7 5/16	8-0
4080	4-0 3/4	4-0 13/16	7-11 7/8	7-8 5/16	8-0	7-8 5/16	8-0

*Legend HBR in-swing patio door available in all sizes (except 9'0", 10'0" and seg-tops) and have the same rough opening dimensions.



Pinnacle Out-swing Patio Door

When space is at a premium, an out-swing is the perfect solution.

- Clad doors available in heavy-duty extruded aluminum cladding
- Clad doors available in Clear Select Pine, Douglas Fir, Natural Alder, primed, painted white or painted black interior finishes
- All clad colors painted in-house with the highly durable AAMA 2604 standard finish, or upgrade to AAMA 2605 for the most challenging of environments – 22 standard colors; 21 feature colors; 8 anodized finishes; custom colors available
- “Easy Adjust” hinge system for effortless operation and correction after installation; non-removable-pin ball bearing hinge also available
- Active stiles constructed of an LVL core material for added strength and stability
- Integral structural astragal allows for doors up to 12 feet wide to be placed in a single frame, which decreases the potential for air and water infiltration
- Wept sill system to eliminate water infiltration
- Heavy-duty, self-adjusting sweep
- Single or bi-hinge panel operation
- Panels available in traditional French or contemporary narrow stile
- Low clearance (ADA-approved) sill option
- Oak interior sill; exterior sill available in mill or bronze anodized finishes
- Rigid aluminum nail fin
- Stainless steel multi-point locking hardware option for added security
- 1/2 and 3/4 lite available with flat or split panel option
- Seg-top available
- Five standard heights: 6'8", 6'10", 8'0", 9'0" and 10'0" (9'0" and 10'0" doors available in French panels only)

PINNACLE DIRECT SET WINDOWS AND OUT-SWING NARROW STILE PATIO DOOR. Washington, D.C.

Measurements* Widths and heights are rough opening dimensions. (C = Clad)

Single Panel Units					Single Panel Units					Single Panel Units					Single Panel Units				
UNIT	C-WIDTH	HEIGHT	C-LEG	C-RADIUS	UNIT	C-WIDTH	HEIGHT	C-LEG	C-RADIUS	UNIT	C-WIDTH	HEIGHT	C-LEG	C-RADIUS	UNIT	C-WIDTH	HEIGHT	C-LEG	C-RADIUS
2668	2-7	6-7 1/2	-	-	2868	2-9	6-7 1/2	-	-	3068	3-1	6-7 1/2	-	-	3268	3-2 1/2	6-7 1/2	-	-
26610	2-7	6-10 3/8	6-6 17/32	3-0	28610	2-9	6-10 3/8	6-6 1/16	3-0	30610	3-1	6-10 3/8	6-4 31/32	3-0	32610	3-2 1/2	6-10 3/8	6-4 17/32	3-0
26880	2-7	7-11 3/8	7-7 17/32	3-0	28880	2-9	7-11 3/8	7-7 1/16	3-0	30880	3-1	7-11 3/8	7-5 31/32	3-0	32880	3-2 1/2	7-11 3/8	7-5 17/32	3-0
2690	2-7	8-11 3/8	8-7 17/32	3-0	2890	2-9	8-11 3/8	8-7 1/16	3-0	3090	3-1	8-11 3/8	8-5 31/32	3-0	32610	3-2 1/2	8-11 3/8	-	-
26100	2-7	9-11 3/8	-	-	28100	2-9	9-11 3/8	-	-	30100	3-1	9-11 3/8	-	-	32100	3-2 1/2	9-11 3/8	-	-

Double Panel Units					Double Panel Units					Double Panel Units					Double Panel Units				
UNIT	C-WIDTH	HEIGHT	C-LEG	C-RADIUS	UNIT	C-WIDTH	HEIGHT	C-LEG	C-RADIUS	UNIT	C-WIDTH	HEIGHT	C-LEG	C-RADIUS	UNIT	C-WIDTH	HEIGHT	C-LEG	C-RADIUS
5068	5-0 13/16	6-7 1/2	-	-	5468	5-4 13/16	6-7 1/2	-	-	6068	6-0 13/16	6-7 1/2	-	-	6468	6-3 13/16	6-7 1/2	-	-
50610	5-0 13/16	6-10 3/8	6-5 1/16	8-0	54610	5-4 13/16	6-10 3/8	6-4 3/8	8-0	60610	6-0 13/16	6-10 3/8	6-2 27/32	8-0	64610	6-3 13/16	6-10 3/8	6-2 7/32	8-0
5080	5-0 13/16	7-11 3/8	7-6 1/16	8-0	5480	5-4 13/16	7-11 3/8	7-5 3/8	8-0	6080	6-0 13/16	7-11 3/8	7-3 27/32	8-0	6480	6-3 13/16	7-11 3/8	7-3 7/32	8-0
5090	5-0 13/16	8-11 3/8	8-6 1/16	8-0	5490	5-4 13/16	8-11 3/8	8-5 3/8	8-0	6090	6-0 13/16	8-11 3/8	8-3 27/32	8-0	6490	6-3 13/16	8-11 3/8	-	-
50100	5-0 13/16	9-11 3/8	-	-	54100	5-4 13/16	9-11 3/8	-	-	60100	6-0 13/16	9-11 3/8	-	-	64100	6-3 13/16	9-11 3/8	-	-

Triple Panel Units					Triple Panel Units					Triple Panel Units					Triple Panel Units				
UNIT	C-WIDTH	HEIGHT	C-LEG	C-RADIUS	UNIT	C-WIDTH	HEIGHT	C-LEG	C-RADIUS	UNIT	C-WIDTH	HEIGHT	C-LEG	C-RADIUS	UNIT	C-WIDTH	HEIGHT	C-LEG	C-RADIUS
7668	7-6 5/8	6-7 1/2	-	-	8068	8-0 5/8	6-7 1/2	-	-	9068	9-0 5/8	6-7 1/2	-	-	9668	9-0 5/8	6-7 1/2	-	-
76610	7-6 5/8	6-10 3/8	6-2 11/16	12-0	80610	8-0 5/8	6-10 3/8	6-12 1/32	12-0	90610	9-0 5/8	6-10 3/8	5-11 13/32	12-0	96610	9-0 5/8	6-10 3/8	7-0 13/32	12-0
7680	7-6 5/8	7-11 3/8	7-3 11/16	12-0	8080	8-0 5/8	7-11 3/8	7-22 1/32	12-0	9080	9-0 5/8	7-11 3/8	7-0 13/32	12-0					
7690	7-6 5/8	8-11 3/8	-	-															

Quad Panel Units					Quad Panel Units					Quad Panel Units					Quad Panel Units				
UNIT	C-WIDTH	HEIGHT	C-LEG	C-RADIUS	UNIT	C-WIDTH	HEIGHT	C-LEG	C-RADIUS	UNIT	C-WIDTH	HEIGHT	C-LEG	C-RADIUS	UNIT	C-WIDTH	HEIGHT	C-LEG	C-RADIUS
16-50-1668	8-0 1/16	6-7 1/2	-	-	20-50-2068	9-0 9/16	6-7 1/2	-	-	26-50-2668	10-0 9/16	6-7 1/2	-	-	30-30-3068	12-09/16	6-7 1/2	-	-
16-50-16610	8-0 1/16	6-10 3/8	-	-	20-50-20610	9-0 9/16	6-10 3/8	-	-	26-50-26610	10-0 9/16	6-10 3/8	-	-	30-60-30610	12-09/16	6-10 3/8	-	-
16-60-1668	9-0 9/16	6-7 1/2	-	-	20-60-2068	10-0 9/16	6-7 1/2	-	-	26-60-3068	11-0 9/16	6-7 1/2	-	-					
16-60-16610	9-0 9/16	6-10 3/8	-	-	20-60-20610	10-0 9/16	6-10 3/8	-	-	26-60-30610	10-0 9/16	6-10 3/8	-	-					

Bi-hinge Units (only)				
UNIT	C-WIDTH	HEIGHT	C-LEG	C-RADIUS
4068	4-0 9/16	6-7 1/2	-	-
40610	4-0 9/16	6-10 3/8	6-6 13/16	8-0
4080	4-0 9/16	7-11 3/8	7-7 13/16	8-0

*Legend HBR not available as an out-swing patio door.



Pinnacle Sliding Patio Doors

Smooth, sleek and incredibly charming. Whether you choose traditional French or contemporary narrow stiles, Pinnacle sliding doors will be the talk of your next outdoor event with their incredible ease and aesthetics. With up to four panels, the doors glide effortlessly on two end adjustable tandem steel ball bearing rollers. Sliding doors have a pultruded fiberglass sill available in a gray or bronze finish. The heavy-duty weatherstripping also ensures your patio doors will be ready for the changing seasons, even when your patio is not.

NOTE: Primed sliding patio doors come standard with cellular PVC exterior trim.

PINNACLE CASEMENT AND DIRECT SET WINDOWS, AND NARROW SLIDING PATIO DOOR. Cleveland, Ohio.





Pinnacle Sliding Patio Door

A space-saving option with traditional looks and modern performance.

- Clad doors available in heavy-duty extruded aluminum cladding; primed doors come standard with cellular PVC exterior trim for a traditional, decorative appearance
- Clad doors available in Clear Select Pine, Douglas Fir, Natural Alder, primed, painted white or painted black interior finishes; primed doors available in Clear Select Pine, primed or painted white interior finishes
- All clad colors painted in-house with the highly durable AAMA 2604 standard finish, or upgrade to AAMA 2605 for the most challenging of environments – 22 standard colors; 21 feature colors; 8 anodized finishes; custom colors available
- Panels available in traditional French or contemporary narrow stile; French stile allows for the “look” of a swinging door where space won’t allow for one
- Quad option including four panels in one frame; center panels operate
- Doors slide on two tandem, heavy-duty, end-adjustable, ball bearing rollers for years of smooth, trouble-free operation
- All stiles constructed of an LVL core for a stronger, straighter, more durable door
- Wood parting stops and absence of screws provide a warm, clean look
- Aluminum jamb covers at the head and strike jambs hide exposed screws and provide a smoother, more attractive surface
- Heavy-duty interlock improves air and structural performance
- One-piece, fiberglass pultruded sill minimizes cold conduction; available in gray or bronze
- Heavy-duty extruded screen ensures durability and smooth operation
- Standard two-point lock for added security
- Integral nail fin on clad doors
- Five standard heights: 6’8”, 6’10”, 8’0”, 9’0” and 10’0” (9’0” and 10’0” doors available in clad French slider only)

PINNACLE DIRECT SET WINDOWS AND NARROW STILE SLIDING PATIO DOOR. Washington, D.C.

Measurements** Widths and heights are rough opening dimensions. (Note: Primed door available in French slider only.)

Single Panel Units

UNIT	WIDTH	HEIGHT
2668-S	2-8 3/4	6-8
26610-S	2-8 3/4	6-11
2680-S	2-8 3/4	8-0
2690*	2-8 3/4	9-0
26100*	2-8 3/4	10-0

Single Panel Units

UNIT	WIDTH	HEIGHT
3068-S	3-2 3/4	6-8
30610-S	3-2 3/4	6-11
3080-S	3-2 3/4	8-0
3090*	3-2 3/4	9-0
30100*	3-2 3/4	10-0

Single Panel Units

UNIT	WIDTH	HEIGHT
4068-S	4-2 3/4	6-8
40610-S	4-2 3/4	6-11
4080-S	4-2 3/4	8-0
4090***	4-2 3/4	9-0
40100***	4-2 3/4	10-0

Double Panel Units

UNIT	WIDTH	HEIGHT
5068-OX	4-11 3/4	6-8
50610-OX	4-11 3/4	6-11
5080-OX	4-11 3/4	8-0
5090-OX*	4-11 3/4	9-0
50100-OX*	4-11 3/4	10-0

Double Panel Units

UNIT	WIDTH	HEIGHT
6068-OX	5-11 3/4	6-8
60610-OX	5-11 3/4	6-11
6080-OX	5-11 3/4	8-0
6090-OX*	5-11 3/4	9-0
60100-OX*	5-11 3/4	10-0

Double Panel Units

UNIT	WIDTH	HEIGHT
8068-OX	7-11 3/4	6-8
80610-OX	7-11 3/4	6-11
8080-OX	7-11 3/4	8-0
8090***	7-11 3/4	9-0
80100***	7-11 3/4	10-0

Triple Panel Units

UNIT	WIDTH	HEIGHT
7668-OX/S	7-7 3/4	6-8
76610-OX/S	7-7 3/4	6-11
7680-OX/S	7-7 3/4	8-0
7690***	7-7 3/4	9-0
76100***	7-7 3/4	10-0

Triple Panel Units

UNIT	WIDTH	HEIGHT
9068-OX/S	9-1 3/4	6-8
90610-OX/S	9-1 3/4	6-11
9080-OX/S	9-1 3/4	8-0
9090***	9-1 3/4	9-0
90100***	9-1 3/4	10-0

Triple Panel Units

UNIT	WIDTH	HEIGHT
12068-OX/S	12-1 3/4	6-8
12610-OX/S	12-1 3/4	6-11
12080-OX/S	12-1 3/4	8-0
12090***	12-1 3/4	9-0
120100***	12-1 3/4	10-0

Quad Panel Units

UNIT	WIDTH	HEIGHT
10068-OXXO	9-9 5/16	6-8
100610-OXXO	9-9 5/16	6-11
10080-OXXO	9-9 5/16	8-0
10090***	9-9 5/16	9-0
100100***	9-9 5/16	10-0

Quad Panel Units

UNIT	WIDTH	HEIGHT
12068-OXXO	11-9 5/16	6-8
120610-OXXO	11-9 5/16	6-11
12080-OXXO	11-9 5/16	8-0
12090***	11-9 5/16	9-0
120100***	11-9 5/16	10-0

Quad Panel Units

UNIT	WIDTH	HEIGHT
16068-OXXO	15-9 5/16	6-8
160610-OXXO	15-9 5/16	6-11
16080-OXXO	15-9 5/16	8-0
16090***	15-9 5/16	9-0
160100***	15-9 5/16	10-0

*9’0” and 10’0” heights available in clad French slider only.

**Legend HBR French slider available in all sizes (except 9’0” and 10’0” heights) and have the same rough opening dimensions. Legend HBR not available as a narrow slider.

***Coming fall 2018 – French panel only.





Pinnacle

Bi-fold Patio Doors

Open up your world. Quality, high-performance and stunning beauty come together with Pinnacle bi-fold patio doors. We offer this versatile product in many sizes and configurations, which allows for installation in standard construction openings. This innovative concept brings open-air luxury to virtually any custom project.

Our bi-fold patio doors feature a revolutionary hinge system that will provide graceful operation and reliable function for years to come. With options including three premium hardware finishes,

43 clad colors, eight anodized finishes and a wood interior selection of Clear Select Pine, Natural Alder and Douglas Fir, your possibilities are wide open. Imagine how our bi-fold patio doors can enhance your projects. Homeowners love the way these doors bring the beauty of nature into their home. Pinnacle bi-fold doors are offered in five heights: 6'8", 6'10", 8'0", 9'0" and 10'0" and can be assembled with as few as two panels, and up to eight panels wide. Imagine having the capability to span an opening as high as 10' tall and as long as 24' wide!

Pinnacle Bi-fold Patio Door

Let the beauty of nature into your home.

- Multi-point locking system on passage panels features three-point jamb-engaged tongue system for uncompromised security
- Centor Architectural E3 bi-fold hardware system provides stability and smooth operation
- Lever handle activated head and sill twin bolt system for added security
- Wept sill system to eliminate water infiltration
- Dual weatherstrips at panel edge improve air and thermal performance
- Stiles constructed of an LVL core material for added strength and stability
- Panels available in traditional French or contemporary narrow stile
- Five standard heights: 6'8", 6'10", 8'0", 9'0" and 10'0" (9'0" and 10'0" doors available in French panels only)
- Custom sizes available
- Two weatherstrip barriers between each panel and between panels and frame; urethane foam encased in polyethylene film around entire frame; pile weatherstripping along head and sill provide added protection
- Interior – Clear Select Pine, Douglas Fir or Natural Alder
- Exterior – Heavy-duty extruded aluminum cladding
- All clad colors painted in-house with the highly durable AAMA 2604 standard finish, or upgrade to AAMA 2605 for the most challenging of environments – 22 standard colors; 21 feature colors; 8 anodized finishes; custom colors available

	Handing	Number of Panels	Call-out Width	Frame Width	Rough Opening Width
Inside Outside 	2L 2R	2	6-0	6-1 15/16	6-2 15/16
	Cannot be opened from the exterior				
Inside Outside 	2L-1R 1L-2R	3	9-0	9-2 1/16	9-3 1/16
Inside Outside 	3L-0R 0L-3R	3	9-0	9-2 5/8	9-3 5/8
Inside Outside 	2L-2R 2L-2R	4	12-0	12-2 1/16	12-3 1/16
	Cannot be opened from the exterior				
Inside Outside 	4L-0R 0L-4R	4	12-0	12-2 1/16	12-3 1/16
	Cannot be opened from the exterior				
Inside Outside 	3L-1R 1L-3R	4	12-0	12-2 1/8	12-3 1/8
	Specify RHA or LHA				
Inside Outside 	5L-0R 0L-5R	5	15-0	15-2 1/8	15-3 1/8
Inside Outside 	3L-2R 2L-3R	5	15-0	15-2 1/8	15-3 1/8
Inside Outside 	4L-1R 1R-4L	5	15-0	15-2 1/8	15-3 1/8
Inside Outside 	6L-0R 0L-6R	6	18-0	18-2 1/8	18-3 1/8
	Cannot be opened from the exterior				
Inside Outside 	3L-3R	6	18-0	18-2 3/16	18-3 3/16
	Specify RHA or LHA				
Inside Outside 	5L-1R 1L-5R	6	18-0	18-2 3/16	18-3 3/16
Inside Outside 	7L-0R 0R-7L	7	21-0	21-2 3/4	21-3 3/4
Inside Outside 	4L-3R 3L-4R	7	21-0	21-2 1/4	21-3 1/4
Inside Outside 	5L-2R 2L-5R	7	21-0	21-2 1/4	21-3 1/4
Inside Outside 	6L-1R 1R-6L	7	21-0	21-2 1/4	21-3 1/4
Inside Outside 	4L-4R	8	24-0	24-2 1/4	21-3 1/4
	Cannot be opened from the exterior				
Inside Outside 	7L-1R 1L-7R	8	24-0	24-2 5/16	24-3 5/16
Inside Outside 	5L-3R 3L-5R	8	24-0	24-2 5/16	24-3 5/16
	Specify RHA or LHA				
Inside Outside 	8L-0R 0L-8R	8	24-0	24-2 1/4	24-3 1/4
	Cannot be opened from the exterior				

11



Pinnacle Multi-slide Patio Doors

Enhance your views. Whether your home overlooks a beautiful cityscape or a quiet lake, Pinnacle multi-slide patio doors create an impactful design element. Highlight brilliant outdoor views and give your home a unique architectural look that expands the feel of indoor living space.

Available in stacking or pocket configurations up to 20 feet wide, our clad multi-slide patio doors offer many of the same features as other products in the Pinnacle line. Choose from 22 standard colors, 21 feature colors, 8 anodized colors, one of three wood species, and a variety of glazing options and grille designs.

Pinnacle Multi-slide Patio Door

Highlight exceptional outdoor views while expanding interior living spaces.

- Stacking and pocket configurations
 - Stacking multi-slide door systems stack all panels in line with the stationary panel when the panels are in the fully-open position; in the stacking configuration, all panels are still visible
 - Pocketed multi-slide door systems incorporate a pocket in the wall cavity to conceal all panels when they are in the fully-open position; in the pocketed configuration, all panels are hidden in the pocket
- Single-direction handing; all panels operate either all-left or all-right
- Door jamb widths vary depending on the number of panels in the multi-slide system
- One panel (pocket only) to eight panel configurations with maximum 20'0" frame width
- All applications using multi-slide door systems require overhangs equal to or greater than the height of the multi-slide door.
- Main frame head jamb and sill use dark bronze anodized aluminum extrusions with powder paint color-matched frame nosing and pocket covers
- Folding aluminum nailing fins applied
- Pinnacle 1-3/4" thick sliding patio door panels
- Heavy-duty interlock improves air and structural performance
- Panels slide on two tandem, heavy-duty, end-adjustable ball bearing rollers for years of smooth, trouble-free operation
- Standard heights
 - French panels: 6'8", 6'10", 8'0", 9'0", 10'0"
 - Narrow panels: 6'8", 6'10", 8'0"
- Panel width callouts: 2'6", 3'0", 4'0"
- Maximum frame width: 20'0"
- All clad colors painted in-house with the highly durable AAMA 2604 standard finish, or upgrade to AAMA 2605 for the most challenging of environments – 22 standard colors; 21 feature colors; 8 anodized finishes; custom colors available
- Pinnacle sliding patio door end-adjustable roller system
- Pinnacle sliding patio door two-point locking gear and keeper
- Flush mount handles standard on pocket and stacking door systems; available in oil rubbed bronze, faux bronze, black and satin nickel (*figure 1*)
- Flush mount handles standard with a keyed lock
- All panels standard with satin nickel finger pull located at the edge of the lead operating panel (*figure 2*)



Fig. 1



Fig. 2

Door Configurations and Handings

POCKET DOORS

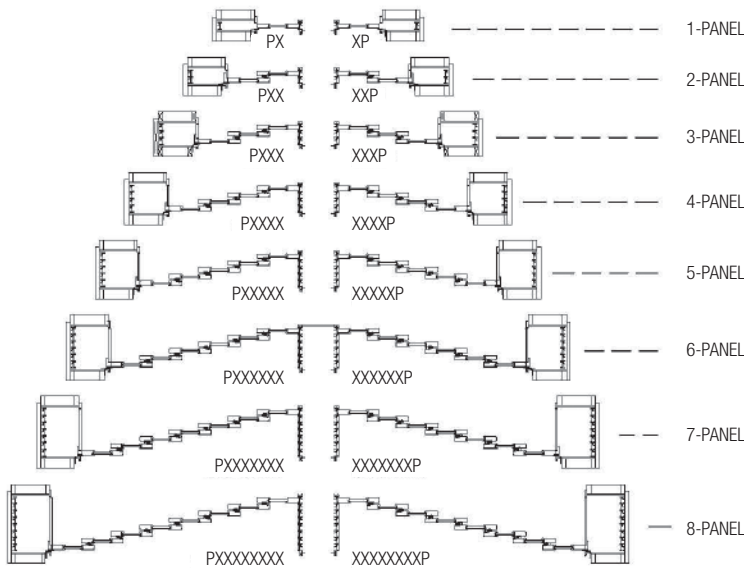

STACKING DOORS

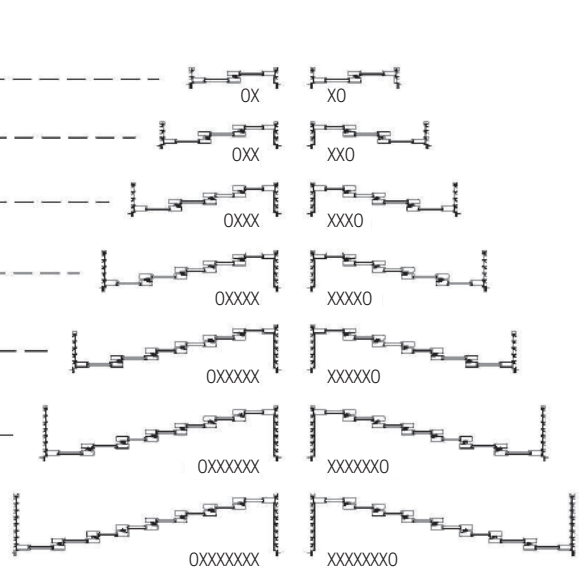

Specifications

Panel Thickness	Maximum Panel Width	Maximum Panel Height	Maximum Number of Panels	Maximum Frame Width	Maximum Frame Height	Minimum Roof Overhang
1-3/4"	4-0 (47-3/4")	Narrow: 8-0 (92-1/2") French: 10-0 (116-1/2")	8	20-0	10-0 (119-1/8")	Equal to door frame height



PINNACLE MULTI-SLIDE PATIO DOORS WITH FRENCH PANELS.
Pacific Palisades, California.

Pinnacle Multi-slide Patio Door

Sills

- Full sill with exterior sill nose and interior riser
- Staggered sill for “flush floor” installation (*NOTE: When using the staggered sill option for a flush track application, there is no interior sill riser to prevent the potential of water infiltration through the sill. Therefore, an interior mop zone is recommended when using the staggered sill option.*)

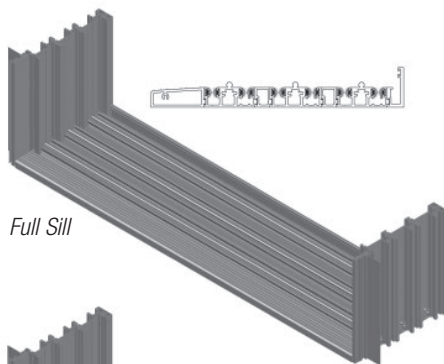

Full Sill

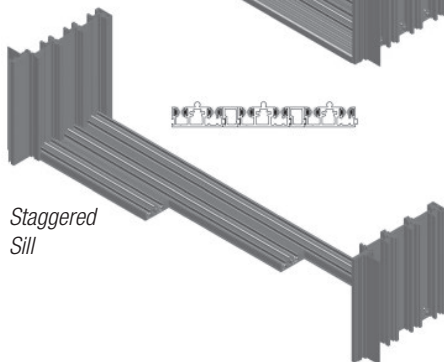

Staggered Sill

Section Details

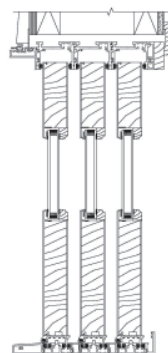

French Panels Full Sill

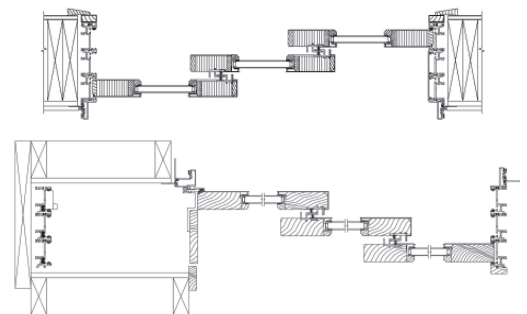

French Panel Stacking and Pocket



Narrow Panels Staggered Sill

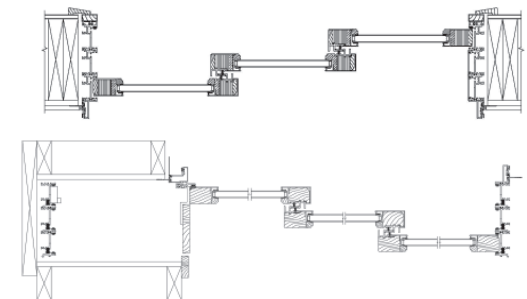

Narrow Panel Stacking and Pocket

Frame and Dimensional Information

Multi Slide Frame Widths													
	French Pocket			French Stacking			Narrow Pocket			Narrow Stacking			
Callout Size	2-6	3-0	4-0	2-6	3-0	4-0	2-6	3-0	4-0	2-6	3-0	4-0	
Panel Size	29.75	35.75	47.75	29.75	35.75	47.75	29.75	35.75	47.75	29.75	35.75	47.75	
Glass Size	21.25	27.25	39.25	21.25	27.25	39.25	25.00	31.00	43.00	25.00	31.00	43.00	
# Panels	1	63.625	75.625	99.625	NA	NA	NA	63.625	75.625	99.625	NA	NA	NA
	2	88.813	106.813	142.813	57.188	69.188	93.188	90.688	108.688	144.688	59.063	71.063	95.063
	3	114.000	138.000	186.000	82.375	100.375	136.375	117.750	141.750	189.750	86.125	104.125	140.125
	4	139.188	169.188	229.188	107.563	131.563	179.563	144.813	174.813	234.813	113.188	137.188	185.188
	5	164.375	200.375	272.375	132.750	162.750	222.750	171.875	207.875	279.875	140.250	170.250	230.250
	6	189.563	231.563	NA	157.938	193.938	NA	198.938	240.938	NA	167.313	203.313	NA
	7	214.750	262.750	NA	183.125	225.125	NA	226.000	274.000	NA	194.375	236.375	NA
	8	239.938	NA	NA	208.313	NA	NA	253.063	NA	NA	221.438	NA	NA

Pocket Widths (PW)							Jamb Depth (JD)	Pocket Depth (PD)	
	French Pocket			Narrow Pocket			All Types and Sizes	All Types and Sizes	
Callout Size	2-6	3-0	4-0	2-6	3-0	4-0			
Panel Size	29.75	35.75	47.75	29.75	35.75	47.75			
Glass Size	21.25	27.25	39.25	25.00	31.00	43.00			
# Panels	1	32.375	38.375	50.375	32.375	38.375	50.375	3.875	3.500
	2	32.375	38.375	50.375	32.375	38.375	50.375	6.375	6.000
	3	32.375	38.375	50.375	32.375	38.375	50.375	8.875	8.500
	4	32.375	38.375	50.375	32.375	38.375	50.375	11.375	11.000
	5	32.375	38.375	50.375	32.375	38.375	50.375	13.875	13.500
	6	32.375	38.375	NA	32.375	38.375	NA	16.375	16.000
	7	32.375	38.375	NA	32.375	38.375	NA	18.875	18.500
	8	32.375	NA	NA	32.375	NA	NA	21.375	21.000

Frame Heights (FH)					
Callout Size	6-8	6-10	8-0	9-0	10-0
Panel Size	76.5	79.5	92.5	104.5	116.5
Glass (Narrow)	71.75	74.75	87.75	NA	NA
Glass (French)	64	67	80	92	104
Frame Height	79.125	82.125	95.125	107.125	119.125



VERTICAL

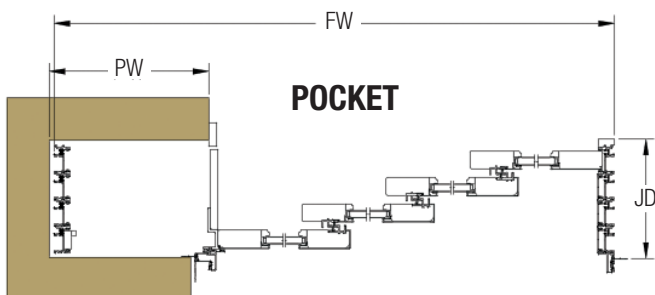

POCKET

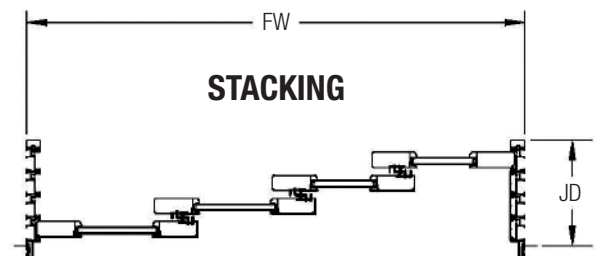

STACKING



Next Dimension Sliding Patio Doors

Your sliding work of art. Our Next Dimension line of sliding patio doors are highly durable, effortless to open and close, and feature a long list of accessories, screens, blinds between the glass and glass options for a look all your own.

Next Dimension vinyl sliding patio doors hold to the same standard of quality as our windows. Employing heavy-duty screens, fusion-welded corners, multi-chamber reinforced extrusions and a positive pressure

draining system, our sliding patio doors offer smooth operation, durability and weatherproofing.

Building on the ease-of-use and long-lasting performance, Next Dimension sliding patio doors can be fitted with an optional blinds between the glass system. Featuring simple, no-cord operation safe for pets and children, lift and tilt functionality and effortless cleaning, patio doors with blinds between the glass are designed to offer a no-hassle solution to let you control natural light and privacy in your home.



Next Dimension Sliding Patio Door

Low maintenance meets effortless operation in Next Dimension patio doors.

- 4-1/2" frame width built from thick vinyl extrusions
- Fusion-welded frame and panel corners increase strength and maximize weatherproof performance
- Aluminum reinforcement in both interlock stiles for added strength and security
- Smooth operation on four adjustable steel ball bearing rollers on a stainless steel track
- Matching standard transom and sidelite additions for beautiful combinations
- Extruded aluminum threshold cover to protect sill and prevent debris build-up
- Reversible handing in the field before installation (except 8'0" heights)
- Triple fin weatherstripping for improved protection against air and water infiltration
- Panel anti-lift blocks for added security
- Heavy-duty extruded screen
- Blinds between the glass option available
 - 1" OA insulated glass in clear IG
 - UV-coated 12.5 mm aluminum blinds
 - Blinds available in white only
 - Robust internal mechanisms assure operational durability
 - Tested to 10,000 raise and lower cycles; equivalent of 20 years of actual use
 - Efficient force-to-lift ratio for the lift and tilt mechanisms
 - Blinds are handed for OX and XO door operation
- D-shaped handle offered in white, clay, satin nickel, faux bronze and black
- Available in standard white or clay, with seven additional painted exterior colors to choose from
- Black painted interior available

NEXT DIMENSION SLIDING PATIO DOOR WITH PLAZA GRILLE PATTERN. Cedar Rapids, Iowa.

Measurements

Call-out codes are rough opening sizes in feet and inches; frames are built 1/2" smaller in width and height.

Call-out	Call-out	Call-out	Call-out	Call-out
5068-XO	6068-OX	7668-OXS	8068-XO	9068-OXS
50610-XO	60610-OX	76610-OXS	80610-XO	90610-OXS
5080-XO	6080-OX	7680-OXS	8080-XO	9080-OXS

Blinds Between the Glass

All vinyl sliding patio doors are handed from the exterior. The images shown below are viewed from the interior looking out to show proper location of blind/tilt and raise/lower mechanism.

Sizes available in OX, XO and Stationary

- 2668S
- 26610S
- 3068S
- 30610S
- 5068
- 50610
- 6068
- 60610

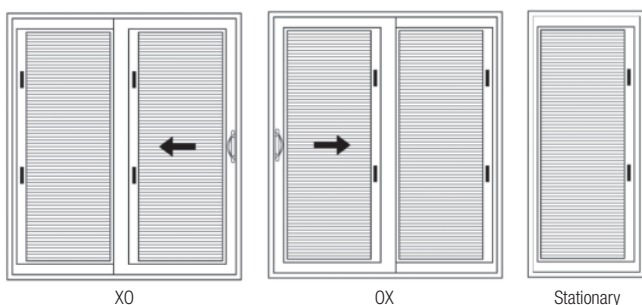

Custom Creations

Finishing touches to perfect your vision. Windsor does more than just create durable, high-performance windows and doors. We pay attention to every detail and offer a wide array of options and finishes to match any décor. Flashy and eye-catching or simple and understated, our hardware, finishes, grille options, cladding colors, glass options and trim options complete the perfect window and door package.

See the difference paint can make. Windsor's in-house powder paint application can help you make a statement with your windows and doors. Choose from over 40 shades in our standard and feature color palettes, or make it truly unique with custom color matching. All paints are protected with the highly durable 2604 finish, or you can upgrade to 2605 for even stronger defense against the elements.¹

Standard Clad Colors (For Pinnacle and Legend HBR)



Feature Clad Colors (For Pinnacle and Legend HBR)

Custom color matching is also available.



¹2604 finish backed by a 20-year* warranty; 2605 finish backed by a 30-year* warranty; applications within one mile of the coast carry a 10-year warranty. For specific warranty details, please refer to the complete warranty document posted on our website, www.windsorwindows.com.

Anodized Finishes *(For Pinnacle and Legend HBR)*

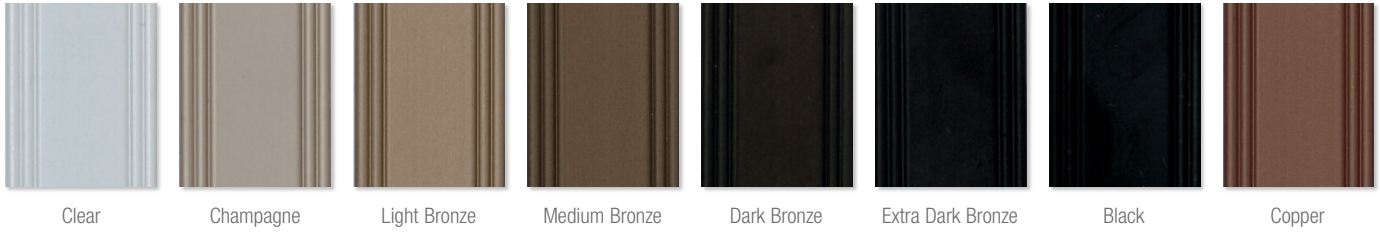

Standard Vinyl Colors *(For Next Dimension)*

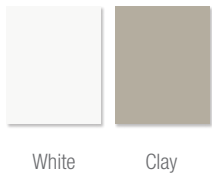

Painted Vinyl Exterior Colors *(For Next Dimension)*

White vinyl interior is available with white, ivory, tan, bronze, cinnamon, hunter green or black exterior. Clay vinyl interior is available with bronze or black exterior.

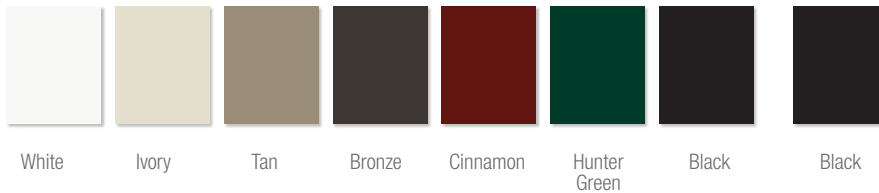

Painted Vinyl Interior Colors *(For Next Dimension)*

Interior Wood Species and Finishes *(For Pinnacle and Legend HBR)*

Pinnacle bi-fold and multi-slide patio doors are only available in Clear Select Pine, Douglas Fir and Natural Alder. Legend HBR patio doors are only available in Clear Select Pine, primed, painted white and painted black.



Glass

*Special order item



NOTE: Printing limitations prevent exact color/finish representation. See your Windsor distributor for actual samples.

options & accessories

Grilles

All of our wood and cellular PVC (CPVC) Windsor Divided Lite bars are hand-fitted to ensure a perfect fit.

*Next Dimension patio doors are only available with a 3/4" profiled inner grille in white or clay.



7/8" & 1-1/4"
Perimeter Grille
(Not available on bi-fold)



3/4" & 1"
Profiled Inner Grille*



13/16" Flat Inner Grille
(Not available on bi-fold)



7/8" & 1-1/4"
Interior Wood
Windsor Divided Lite



7/8" & 1-1/4"
Exterior Clad
Windsor Divided Lite



5/8", 7/8" & 1-1/4"
Short and Tall Putty
Windsor Divided Lite



5/8", 7/8" & 1-1/4"
Contemporary Windsor
Divided Lite

Grille Patterns

Some grille patterns are not available in all configurations and products.

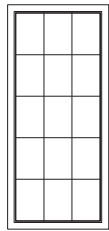

Colonial

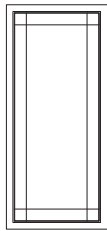

Prairie

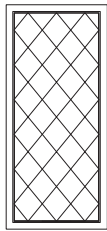

Diamond

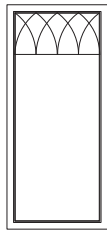

Gothic

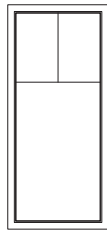

Custom
Plaza

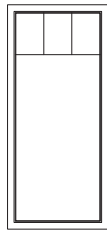

Single
Plaza

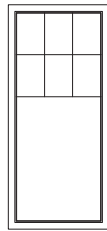

Double
Plaza

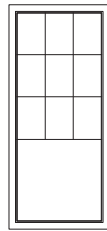

Triple
Plaza

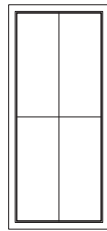

Specified
Equal Lite
(2x2 shown)

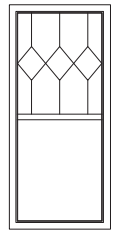

Custom
Pattern
(Example)

Grille Profiles (For Pinnacle and Legend HBR)

Interior Grilles – Ogee



7/8"

1-1/4"

2"

Interior Grilles – Putty



5/8"

7/8"

1-1/4"

Interior Grilles – Contemporary



5/8"

7/8"

1-1/4"

2"

Interior Grilles – Midrail



3-3/8"

Exterior Grilles – Ogee



7/8"

1-1/4"

Exterior Grilles – Putty

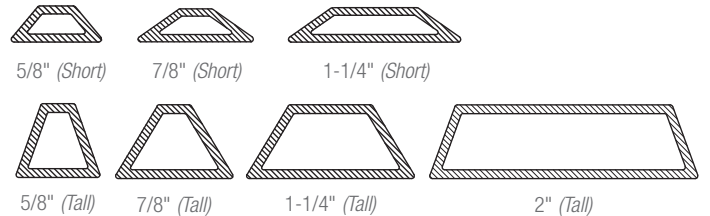

5/8" (Short)

7/8" (Short)

1-1/4" (Short)

5/8" (Tall)

7/8" (Tall)

1-1/4" (Tall)

2" (Tall)

Exterior Grilles – Contemporary



5/8" (Short)

7/8" (Short)

1-1/4" (Short)

2"



5/8" (Tall)

7/8" (Tall)

1-1/4" (Tall)

2" (Tall)

Exterior Grilles – Midrail



3-3/8"

Screens

All exterior-applied screens for Pinnacle patio doors come with screen frames matching the clad color of the unit.

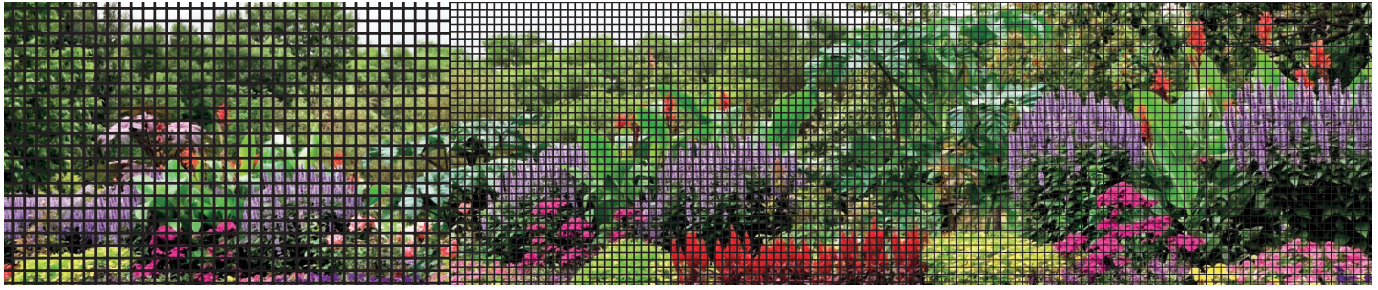

Conventional Screen Mesh

BetterVue® (Standard)

UltraVue®

Exterior Trim (For Pinnacle)



WM 180 Brickmould

Williamsburg

3-1/2" Flat

Exterior Trim (For Pinnacle Primed and Legend HBR)



WM 180
Brickmould

WM 180 Brickmould
with Flange

Williamsburg

3-1/2" Flat

4-1/2" Backband

5-1/2" Flat

Plantation
(3-1/2" Side; 5-1/2" Head)

Accessories (For Next Dimension)



Drywall Return

Mull Groove Filler

Stucco Clip

1/2" Mull Cover

Brickmould
Accessories

Jamb Extension Clip

Standard Drip Cap

NOTE: Printing limitations prevent exact color/finish representation. See your Windsor distributor for actual samples.

options & accessories

Patio Door Handle and Hinge Finishes (For Pinnacle and Legend HBR)

Finishes marked with (*) feature a clear coating that protects the finish against tarnishing and peeling. It extends the rich, bright life of the finish and dramatically delays the aging process.

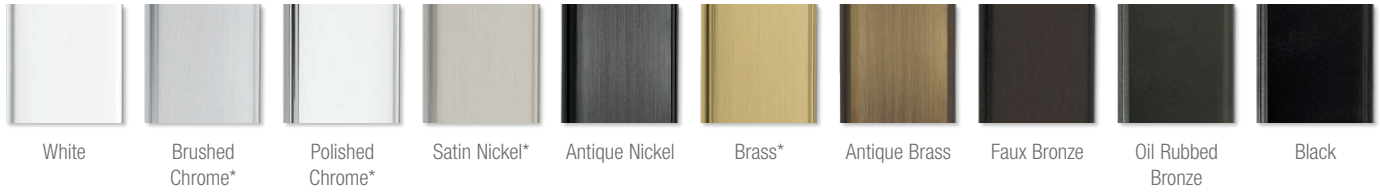

Patio Door Handles (For Pinnacle and Legend HBR)

1/Bi-fold doors are available with a classic or contemporary swinging handle in satin nickel, brass and oil rubbed bronze; 2/Euro swinging handle is only available in satin nickel and black; 3/Flush mount handle is only available in satin nickel, faux bronze, oil rubbed bronze and black.

Sliding Patio Door Handle and Finishes (For Next Dimension)

Finishes are the same for both interior and exterior handles.



Swinging Patio Door Hinges (For Pinnacle and Legend HBR)



Faux Bronze Black

Make every project a success.



Windsor Windows & Doors has distinct product lines for every application. New construction. Room additions. Window replacement. Windsor has the solutions to help meet any home building or home improvement need. Discover all of the products we have to offer.

Pinnacle

The strength and beauty of natural wood define our elite Pinnacle line of products. Crafted from the finest pine, alder and fir, Pinnacle windows and doors add a measure of elegance to any home.

From subtle to showy, Pinnacle products are endlessly customizable through an array of finishes, hardware, shapes, grille options, cladding colors, glass and trim options, allowing the perfect window or door to be created.

Homeowners can choose from the technologically advanced Pinnacle Select, the durable and damage resistant Pinnacle wood clad or Pinnacle primed, which arrives ready to be painted.

Legend

Legend products are constructed from solid cellular PVC, creating the traditional look and feel of painted wood with the low maintenance and strong durability of vinyl. Our windows are protected against rotting, warping, cracking or swelling with a 25-year warranty. Legend products are well suited for both new construction and historical renovation.

Legend HBR products combine the strength and durability of our Legend cellular PVC frame with a wood clad sash. This powerful hybrid offers a low-maintenance exterior with a beautiful wooden interior.

Next Dimension

Next Dimension Signature windows and doors are robust, reliable products that offer the resilience of extruded multi-chambered vinyl. Enhanced components and sturdy construction add strength and stability. Homeowners enjoy exceptional performance and energy efficiency.

Next Dimension Classic is available in single and double hung units, sliders and sliding patio doors. What makes Next Dimension Classic unique is its sloped sill, tilt sash, brickmould profile frame and decorative features, such as a profiled inner grille and simulated divided lite.

Next Dimension Pro vinyl windows and patio doors are designed for light commercial, multi-family and residential applications, all at a highly competitive price. Vinyl extrusions ensure superior weathering, durability and color retention. Construction features are built in to reduce maintenance, add strength and security, and maximize weather resistance.

All Next Dimension vinyl products are available in white or clay, as well as seven painted exterior colors (white, ivory, tan, bronze, cinnamon, hunter green and black). Our vinyl windows are highly rated for performance and many even offer commercially rated performance. All of our vinyl products are low maintenance and are backed by a lifetime limited warranty.

Revive™ Pocket Replacement Windows

There's a lot to love about a home – its unique character, timeless details and genuine craftsmanship. Drafty, unsightly windows can easily steal away from the beauty of these features. That's where Revive pocket replacement windows come into the picture.

Each window can be transformed with stunning Windsor quality in about an hour – with fewer worries about disturbing any treasured wood trim or other interior and exterior features. And because they're meticulously built to order with customizable features in three high-quality materials (wood clad, hybrid and vinyl), Windsor Revive pocket replacement windows are a fast, uncomplicated upgrade.

Revive Sash Replacement Kit

Replace old, drafty, inefficient double hung sashes with energy efficient, dual pane sashes. Windsor's Revive Sash Replacement Kit makes updating easy, allowing homeowners to leave existing interior trim and plaster in place. Choose from three different replacement sashes: versatile primed wood, durable aluminum clad or low-maintenance cellular PVC. Revive sashes feature EZ Tilt, which provides fast access for hassle-free cleaning.



900 South 19th Street • West Des Moines, IA 50265 • 515.223.6660 • 800.218.6186
2210 Stafford Street Extension • Monroe, NC 28110 • 704.283.7459 • 800.205.5665
www.windsorwindows.com

© 2018 Woodgrain Millwork Inc. Woodgrain Millwork, Windsor, the Windsor Lion logo, Next Dimension and Legend are registered trademarks of Woodgrain Millwork Inc. Windsor Windows & Doors, Pinnacle, Revive and Redstone are trademarks of Woodgrain Millwork Inc.



Windsor Windows & Doors is an ENERGY STAR® partner and an NFRC, USGBC and WDMA member. Windsor products are certified and labeled according to the guidelines established by the National Fenestration Rating Council (NFRC).

Connect With Us

